

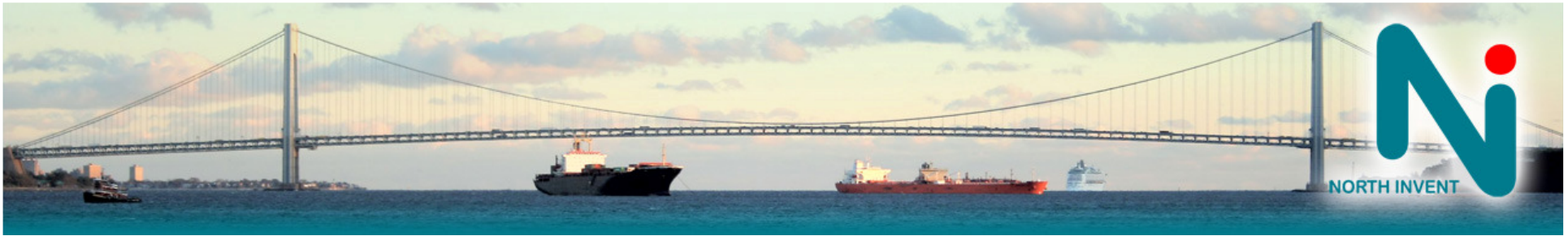

– *Corporate Presentation*

Welcome to North **I**nvent A/S





Business idea



- High quality, industrial LCD monitors, dedicated to the Maritime markets
- Modular concept, allowing for Design flexibility & Shorter lead-times
- Excellent Value for Money, comforting a sound investment



ECDIS certified display solutions
Custom Made / OEM products
All-steps Quality Checks
Excellent Service Level



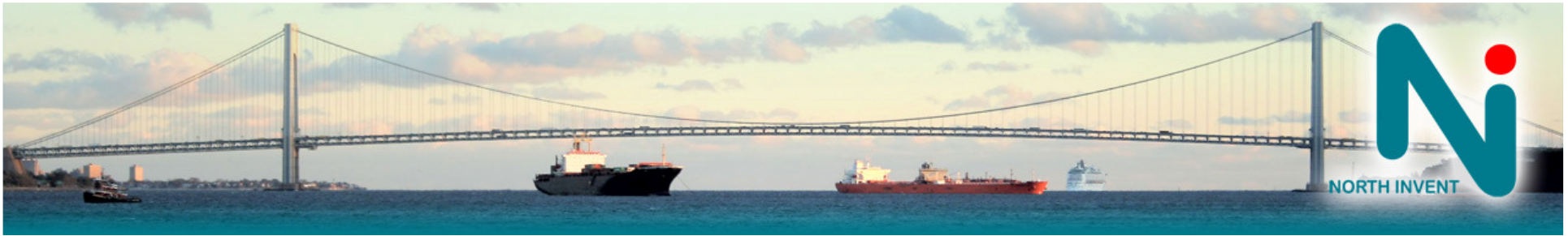

Company in short



- Established in April 2004 in Norway, then moved to Denmark (Copenhagen)
- Moved to current location in Hedensted, Southern Denmark in March 2007
- Share capital of €3.05 Mio

North Invent Design A/S

North Invent A/S

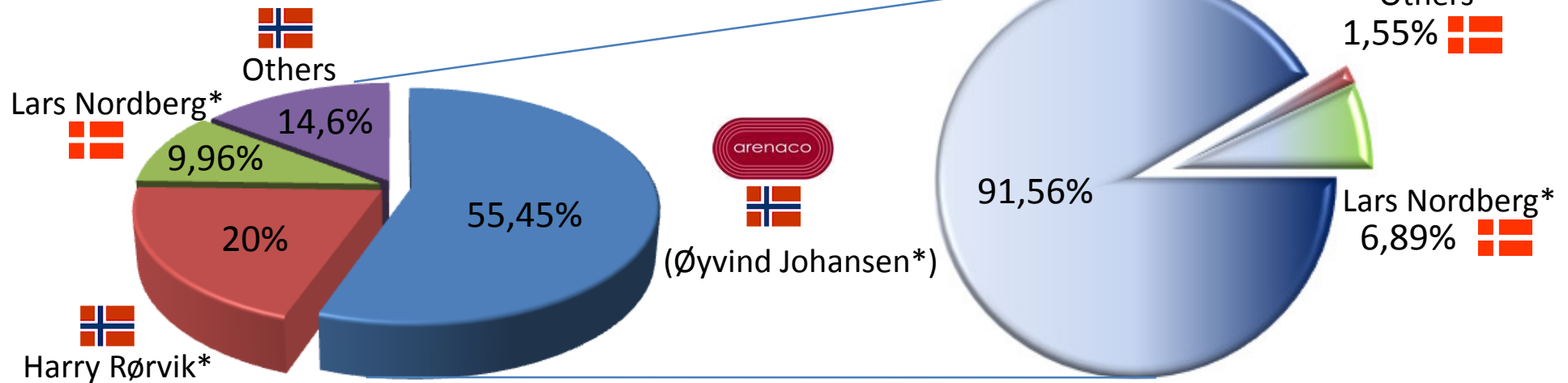



Production facilities



- In-house & outsourced, Electronics & Mechanical R&D
- In-house Dust Reduced mounting, Color Calibration, Burn-in test rooms
- Own, purpose-made, fall-proof shipping cardboards



In-line batch assembly & components mounting



On-going Quality Check



Dust reduced room

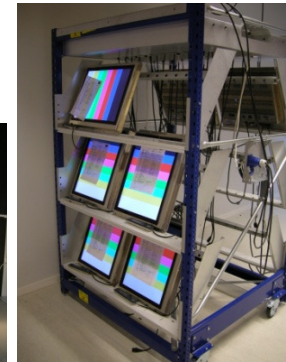

72 hrs burn-in test

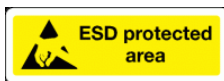

1.600 sqm overall facility



NI product range



- 15", 19", 21.3" and 23.1" MK3 monitor line, ECDIS approved
- Customer specifications-made, OEM versions
- MK2 replacement line, compatible with Market Leader
- O'Sean Line, high-end, all glass monitor for the non-ECDIS markets

discontinued

MK3



23" 19" 15" 21"

OEM



21.3"



15" 19" 21" 23"

MK1



26" WS 19" 15"

O'Sean Line



23.1" 19"

MK2



NI Product platform



- Dual/Single Power Platform
- All purpose Signal Platform (Radar, Sea Charts, Supervising)
- Design Platform: MK3, OEM, O'Sean Line, MK2
- Approval Platform as per Customer Specifications



Stands

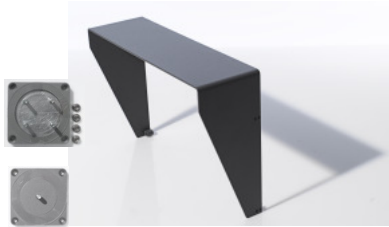

Turntables

Sunshades



15"



19"



21"



23"

26"

-> Frames can be delivered in white, red, blue, black & traditional gray



MK3 Sea Line Key Features



- All MK3 monitors are ECDIS approved
- Whisper silent in use, as Fanless
- All monitors' glass front are Impact Proof

IP67 front

Marine Grade
Aluminium Frame

Membranes buttons
back-light illuminated

True analogue dimming

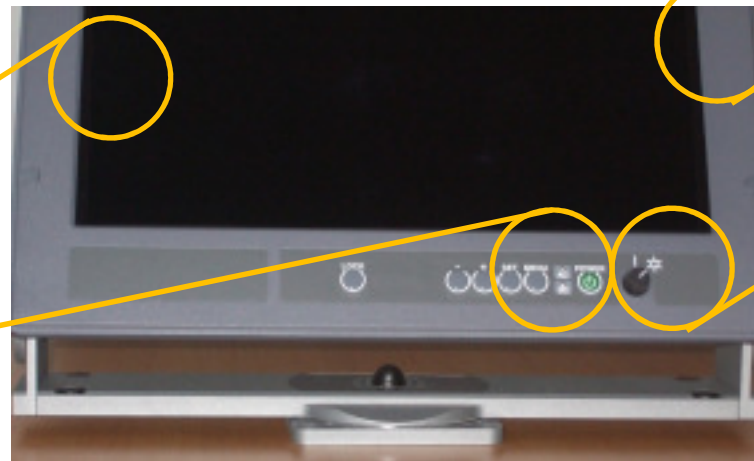



MK3 Sea Line Key Features



- Dual AC/DC power supply
- Digital, Analog, Video inputs
- Secured connections

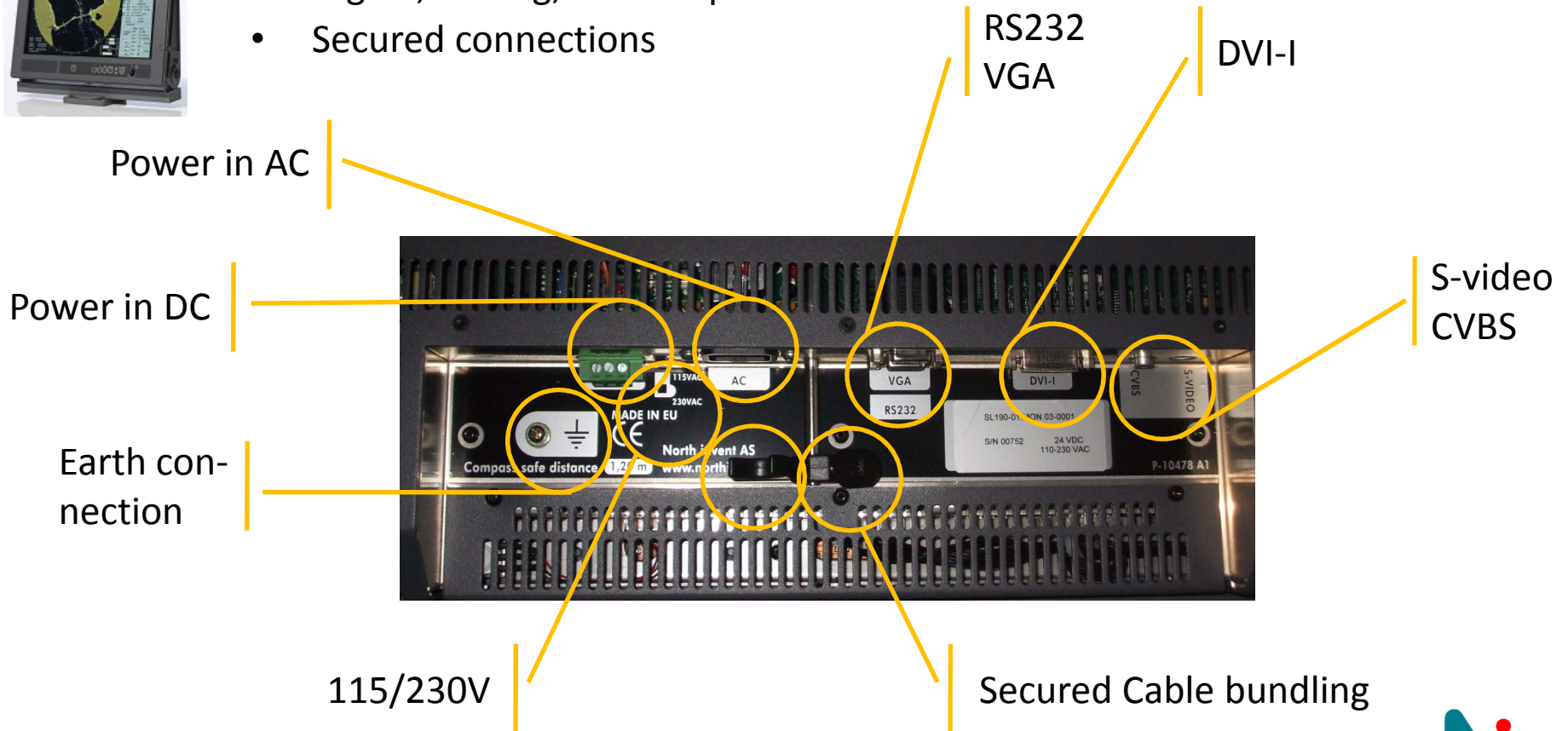



MK3 Sea Line Key Features



- Mode Wizzard
- PIP feature ($\geq 19''$)
- IP67 O'ring back sealing



Mode Wizzard



$\pm 89^\circ$ inclination



PIP



Back sealing

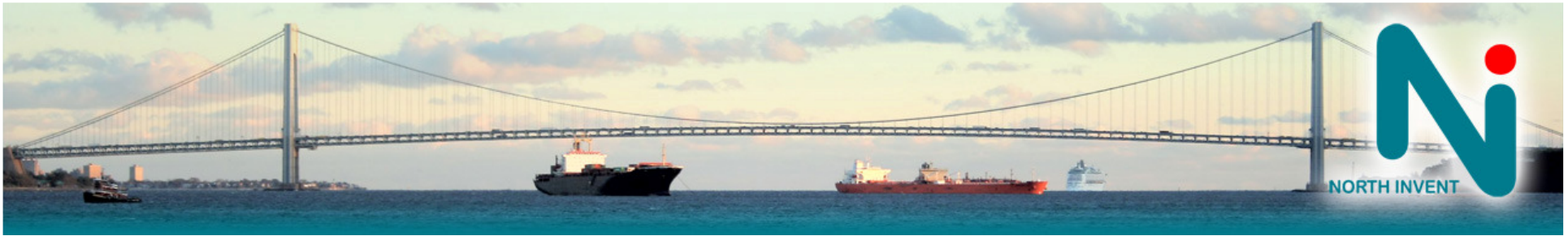

O' Sean Line Glass Front Monitor Key Features



- Single Power Platform, Modular Platform (same key components as MK3)
- Remote control allowing single/multiple remote monitor management
- All purpose, multi source Platform (Radar, Sea Charts, Supervising, Wide Screen)
- Design Platform: O'Sean Line monitors, all sizes, + sealing kits

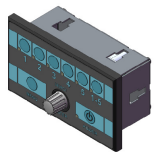

Remote
Control



Sealing Kit



15"



19"



25.5" WS

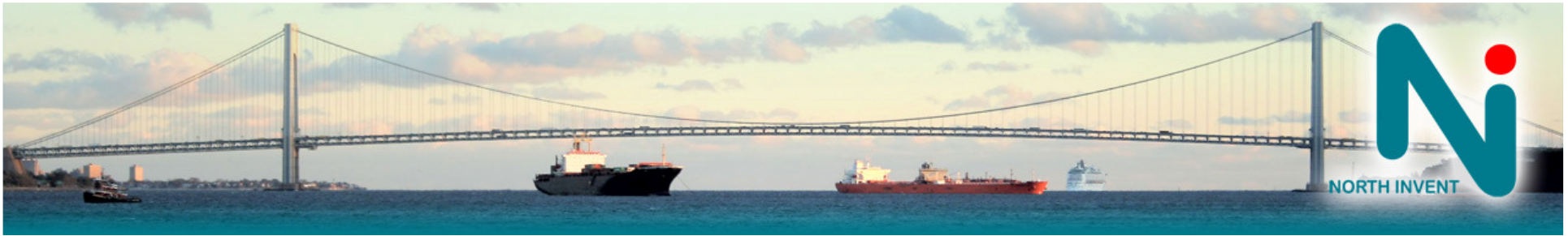

MK2 Sea Line Swap Monitor Key Features



- Identical dimensions & mounting capabilities, as Market leader
- Available in 19" & 23"
- Will be ECDIS approved
- Custom-painted frames





Price Positioning



- FOB prices (Partners, Dealers, recommended End-Users)
- Priced in Euro (€)
- 1 year products warranty under normal Installation, Maintenance & Use.



NI Contacts



Mr. Finn Carlsen
North Invent A/S
Managing Director

+45 87 53 89 01 **Office**
+45 20 34 84 70 **Mobile**
finn.carlsen@northinvent.com

Mosetoften 20
DK-8722 Hedensted



Mr. Laurent Dorey
North Invent A/S
Sales Manager

+45 87 53 89 03 **Office**
+45 20 34 46 15 **Mobile**
laurent.dorey@northinvent.com

Mosetoften 20
DK-8722 Hedensted

